

User's Manual

Home Beauty Device	Photo PLUS Shiny	M18
--------------------	------------------	-----

Table of Contents	Introduction	1	After Treatment	26
	Safety Precautions	1	Additional Information	28
	When Using Outside of Japan.....	9	● Troubleshooting	28
	Names and Functions of Components.....	10	● Frequently Asked Questions	30
	Before Use.....	12	● Product Specifications	31
	How to Use	15	After-sales Service.....	32

English User's Manual come with this product.
 Please download the other language's User's Manual version from this link
 (<https://www.ya-man.co.jp/en/support/documents/>) or scan with QR code with your camera phone.
 Please carefully read User's Manual to ensure safe and proper use of the device.



TO ACCESS SCAN WITH YOUR CAMERA PHONE



Introduction

Thank you for purchasing this YA-MAN product.

- Please read this User's Manual carefully for information on how to use the device properly and safely.
- After reading the contents hereof, be sure to keep this User's Manual in an accessible location.
- Make sure to include this User's Manual if you are transferring ownership of the device to another person.

Safety Precautions

- Read these Safety Precautions carefully before using the device.
- Use the device sensibly in accordance with the prescribed steps.
- Immediately discontinue use and arrange to have the device repaired if any abnormality occurs.
- Do not use the device in a defective state, as doing so could cause a physical harm to the user.
- The precautions listed in the User's Manual are very important. For your safety, please follow them carefully.
- Precautions are classified as DANGER, WARNING, or ATTENTION in order to clearly specify the level of danger and possible injury or damage that may occur if the device is misused.

● Classifications of Precautions



DANGER

Improper use of this device poses a severe and likely risk of death or serious injury.



WARNING

Failure to operate the device according to this type of precaution could result in death or serious injury.



ATTENTION

Improper use of this device may result in an injury or a property damage*.

* 'Property damage' refers to damage affecting dwellings, household belongings, or domestic animals and pets.

● Symbols



This symbol shows you what you must not do.



This symbol shows you what you must do.



This symbol shows you what you must be careful with.

DANGER (Use and storage)

● **The following individuals should not use the device:**

Failure to comply may cause electronic medical devices to malfunction.

- ◆ Do not use the device in conjunction with any medical electronic equipment, including:
 - pacemakers or other implanted electronic medical devices; artificial heart-lung machines or other electronic life-support medical devices; and
 - electrocardiographs or other worn electronic medical devices.



WARNING (Use and storage)

● **Do not use under the following conditions:**

Failure to comply may cause an accident or other problems.

- If you have existing or suspected heart disease, or related disorders
- If you are unable to express your intentions
- If you are unable to sense temperature or stimulation
- If you have an autoimmune disease

Consult a physician prior to use under the following conditions.

- If you have an acute disease
- If you have an infectious disease
- If you have a malignant tumor
- If you have a febrile disease
- If you have high blood pressure or a blood disease
- If you have a fever
- If you have sensory impairment due to severe peripheral circulatory dysfunction (e.g. diabetes)
- If you have nerve damage
- If you have a skin disease or atopic dermatitis
- If you are seeing a physician regularly and are on medication
- If you have an allergy, contact dermatitis, past skin related medical history or any concern about your skin when using this device

● **Do not use in the following cases or on the following areas:**

Failure to comply may cause an accident or other problems.

- If your skin is damaged, experiencing a rash, inflammation, or other abnormalities
- If you are under the influence of alcohol
- Anywhere inside the mouth, around the pubic region, or any mucous membrane
- Eyeballs
- Upper eyelids (except in COOL Mode)
- Lower eyelids, outer corner of the eye (except in EYE CARE Mode and COOL Mode)
- Throat
- Raised moles
- Viral warts
- Areas where you have broken a bone
- Areas with symptoms of internal bleeding, swelling, or scabbing after medical cosmetic treatments
 - * Avoid using the device for 2 weeks after medical cosmetic treatments. After this period, consult with a physician and only use the device after gaining his/her permission (e.g. Hyaluronic acid injections, silicone injections, Botox, thread lifts, double eyelid surgery, HIFU, etc.)
- Areas where metal was implanted by surgery (reconstructive, plastic or cosmetic surgery)

● **Do not use the device continuously for an overly long period (for example, through commercial use).**

Doing so may cause an injury or the generation of heat.



WARNING (Use and storage)

- **Do not use the device for a long time over areas where the skin is thin or areas above bones.**

Failure to comply may cause skin problems or physical ailments.

- **Do not use the device on the areas other than specified areas.**

Failure to comply may cause injuries.

- **Do not use continuously on the same area except when in EYE CARE or COOL Mode. Be sure to move the device across the skin while it is in use. Do not use on areas that cannot be reached by the entire electrode head surface.**

Failure to comply may cause burn injuries.

- **Do not place the device near fire or flames, and do not dispose of the device in a fire. Do not use or store in a high-temperature area or if the device is hot.**

Failure to comply may lead to the generation of heat, a fire or explosion.

- **Do not use the device near a flammable substance (such as alcohol, thinner, benzene nail polish remover or spray).**

Failure to comply may cause a fire, electric shock or other injuries.

- **Do not use or store the device in the following locations:**

- Dusty areas
- A location where there is exposure to direct sunlight
- Uneven or unstable location, or a location where there is vibration or shocks
- An outdoor location
- A location where there are strong radio waves or magnetism
- Locations that are accessible to children
- A location where there is exposure to oil smoke or steam
- A location with drastic temperature changes (for example, near an air conditioner or heater)

Failure to comply may lead to a fire, electric shock, malfunction, failure of the device or other accidents.

- **Do not use the device when an odor or abnormal generation of heat is detected.**

Failure to comply may cause the device to become damaged or catch fire.



Prohibited



Use is prohibited when an abnormal odor or excess heat is detected

- **Do not place heavy items on the device, drop the device (especially during use) or otherwise subject the device to a strong impact.**

Failure to comply may cause an injury or a failure of the device.



Shock is prohibited

- **Do not place the device on an unstable location. Do not drop or strike.**

Doing so may cause a failure of the device. An injury may also be caused if the device is dropped on a foot or other exposed body part.



Dropping of the device is prohibited

- **Do not use the device on individuals who are unable to express their will or who have reduced skin sensitivity. Failure to comply may cause an accident or an injury.**



User restrictions

- **Use by unattended children or individuals with physical disabilities should be avoided. Minors should use the device only with the consent and under the supervision of their parents.**

Failure to comply may cause injuries.

- **Keep the device, charging base, and USB cable away from children and do not allow them to use the device. Do not allow children to play with the device.**

Failure to comply may cause an accident or an injury.

- **Do not use the device for any purpose other than those stated in the User's Manual.**

Failure to comply may cause an injury or a failure of the device.



Non-intended uses are prohibited

WARNING (Use and storage)

- **Do not use or charge the device in the bathroom or near a bathtub, shower, sink or other vessels filled with water.**

Failure to comply may cause an electric shock, short circuit, fire or failure of the device.

- **Do not wet, wash or immerse the device in water.**

Failure to comply may cause an electric shock, short circuit, fire or failure of the device.



Exposure
to water
is prohibited

-
- **Do not disassemble, attempt to repair or modify this device in any way.**

Failure to comply may cause a fire, electric shock or other injuries.

Contact your local distributor for advice on repairing the device.



Disassembly
is prohibited

-
- **Be sure to perform a pre-test before using the device for the first time.**

Failure to comply may cause an accident or an injury.

- **If you are currently undergoing dental treatment or have teeth fillings, choose a lower intensity level and apply the device on a different area.**

You may feel strong irritation or discomfort due to the EMS effect on your cheeks or chin. If you feel strong discomfort, consult a physician.

- **If water or foreign matter gets into the device (such as the main body), immediately discontinue use and request an inspection.**

Failure to comply may lead to a fire or electric shock.



Mandatory
compliance

WARNING (Use and storage)

- **Do not leave the device near fire, in the hot sun, in a bathroom or other high-temperature/high-humidity location or near combustible gas or a flammable object. Do not dispose of the device in a fire or place it near fire or flames. Do not use or charge in a high-temperature area or if the device is hot. Do not bring the device close to a heater.**

The device features a built-in rechargeable battery. Failure to comply may cause the generation of heat, a fire, the explosion of the device or failure of the device.



Fire hazard

- **Do not put the device into a microwave or pressure vessel.**

Failure to comply may lead to the generation of heat, a fire or explosion.



Explosion

ATTENTION (Use and storage)

- **Do not press the device strongly or use it intensively on a single area.**

Pressing the device stronger than necessary or using it intensively on a single area may damage the skin.

- **Avoid letting the electrode head come into a contact with any other metal surfaces or objects.**

Failure to comply may cause the generation of heat, a fire, malfunctions or damage to the device.

- **Before use, check to make sure that the electrode is not cracked, deformed or broken. Do not use the device if it is damaged or malfunctioning.**

Failure to comply may cause skin problems or a malfunctioning of the device.

- **Do not use the device in locations that are extremely hot or cold.**

The recommended temperature range for the device's usage environment is approx. 15 to 30° C.



Prohibited

ATTENTION (Use and storage)

- **Do not wipe the device or charging base with solvents such as alcohol, thinner, benzene, nail polish remover, kerosene, chemicals or polishing powder.**

Failure to comply may cause a damage to the surface of the device.

- **Do not use the device on pets.**

Failure to comply may cause an injury.

- **Do not leave the device on the floor or on top of furniture while it is switched on. Be sure to turn the device off after use.**

Failure to comply may cause injuries or damages the furniture.

- **Do not allow the device to come into a contact with another electronic appliance (electric blankets/bed sheets, heated tables, etc.) while the power is on. Do not use with other electronic products simultaneously.**

Failure to comply may cause an injury or a failure of the device.

- **Do not look directly into the LED light. When using the LED light to treat the upper eyelids, lower eyelids, or outer corner of the eye, be sure to close your eyes and keep the electrode head at least 5 cm away from skin.**

Failure to comply may cause damage to your eyes or skin.

- **Do not use COOL Mode continuously.**

If used for continuous treatments, the head will not fully cool.

To resume using the device, wait at least 30 minutes before proceeding.

- **Do not use the device in combination with peelings or skin pack treatments.**

Failure to comply may cause skin problems.

-
- **Remove any accessories (necklace, belt, rings, earrings, etc.) before using the device.**

Failure to comply may cause an accident or an injury.

- **Use only Level I upon the first use and until you are accustomed to use.**

Failure to comply may cause an accident or an injury.

- **Stop using the device immediately if you feel any pain during use.**

Failure to comply may cause an accident or skin problems.



Prohibited



Mandatory
compliance

ATTENTION (Use and storage)

- **Reapply skincare products or water during treatment to ensure that there is always some moisture between the electrode head and the skin.**

If there is an insufficient amount of skincare product or water, the stimulation will become weaker, causing skin problems.

- **If you feel an unpleasant tingling on your skin, reduce the intensity level or move to another area. You could also moisten your skin with skincare products, such as lotion, before using the device.**

Failure to comply may cause damage to your skin.

- **Carefully clean the parts of the device that come into a contact with the skin every time you use it and keep the device clean at all times.**

Failure to comply may cause skin problems.

- **If you begin feeling ill or if a skin abnormality appears during use, stop using the device immediately.**

Check carefully to make sure there are no skin abnormalities before using the device. Stop using the device immediately if the treatment does not agree with your skin.

- **Be sure to use the device only for the following lengths of time.**

[Daily Care]

- DAILY Mode: up to 3 minutes per treatment, once a day

[Weekly Care]

- CLEAN Mode: up to 3 minutes per treatment, once a day, 2 to 3 times a week
- DYHP Mode: up to 5 minutes per treatment, once a day, 2 to 3 times a week
- EYE CARE Mode: up to 2 minutes per treatment, twice a day, 5 times a week
- COOL Mode: up to 3 minutes per treatment, once a day, 2 to 3 times a week

Do not use Daily Care and Weekly Care (except in EYE CARE Mode) on the same day.

- **Avoid using the device continuously on the same area of skin (except when in EYE CARE Mode).**

When using on the same area again, be sure to leave an interval of 24 hours or more between treatments.

Excessive use may damage the skin.

The above recommendations are merely guidelines. Please observe your skin condition and use the device accordingly.

- **After each use, be sure to remove dirt and other particles that have adhered to the device according to 'After Treatment' (page 26).**

Failure to comply may cause skin problems or a malfunctioning of the device.



Mandatory
compliance

WARNING (Power supply)

- **Do not damage, modify or bundle the USB charging cable.**

Do not place heavy objects on the USB charging cable or allow it to get pinched in between other objects as this may damage the cable and cause a fire or electrical shock hazard.



Careless or reckless use is prohibited

- **Do not pull the USB charging cable when moving or lifting the device.**

Failure to comply may break the cable or cause an electric shock, short circuit or fire.



Moving the device by pulling its cords is prohibited

- **Do not use the device if the USB charging cable is damaged or if the USB port is loose.**

Failure to comply may cause an electric shock, short circuit or fire. Contact your local distributor for advice on repairing the device.



Use of a damaged cable or plug is prohibited

- **When unplugging the USB charging cable from the device and the USB port, do so by gripping the USB plug (do not touch the metal parts). Do not insert or disconnect the plug with wet or damp hands.**

Failure to comply may cause an electric shock, short circuit or fire.



Removing the plug

- **When cleaning the device, be sure the power is switched off. When the device is not in use, disconnect the USB charging cable from the device. Do not insert or disconnect the plug with wet or damp hands.**

Failure to comply may cause an electric shock, short circuit or fire.

- **Do not wash or submerge the USB charging cable in water.**

Failure to comply may cause an electric shock, short circuit, fire or a failure of the device.



Exposure to water is prohibited

- **Make sure that the USB charging cable is fully inserted into the USB port.**

Failure to comply may cause a fire, an electric shock or a failure of the device.



Mandatory Compliance

- **Be sure to use the dedicated USB charging cable supplied with the product. Plug the AC adapter (commercially available) directly into a wall outlet and do not overload the electric circuit.**

Failure to comply may cause an electric shock, short circuit, fire or failure of the device.

- **Before charging the device, check to make sure there is no lotion on the charging terminal.**

Failure to comply may cause an electric shock, short circuit or fire.

- **In the unlikely event that an abnormality occurs, turn off the device immediately.**

Refrain from using the device if faulty operation, smoke, abnormal noises, or odors are detected or if it is otherwise operating in an abnormal state.

- **When you feel an earthquake or hear a thunder, stop using the device and turn it off. If the device is charging, remove the USB charging cable from the device.**

- **Do not plug the AC adapter (commercially available) into a power outlet or charge the device when there is lotion or other liquid in the charging base.**



Prohibited

When Using Outside of Japan

WARNING

- **Use only with a 5 V DC USB power supply.**

Failure to comply may cause a fire, electric shock or a failure of the device.



- **Be sure to check the plug configuration and the voltage of the power outlet before use.**

Failure to comply may cause the generation of heat, a fire, or a malfunction of the device.



- The plug configuration and voltage may vary depending on the region and the type of accommodation. Always be sure to check for compatibility before using the device.
- For information about plug adapters, consult a travel agency or a consumer electronics retailer.

Names and Functions of Components

Main Body

● Front view

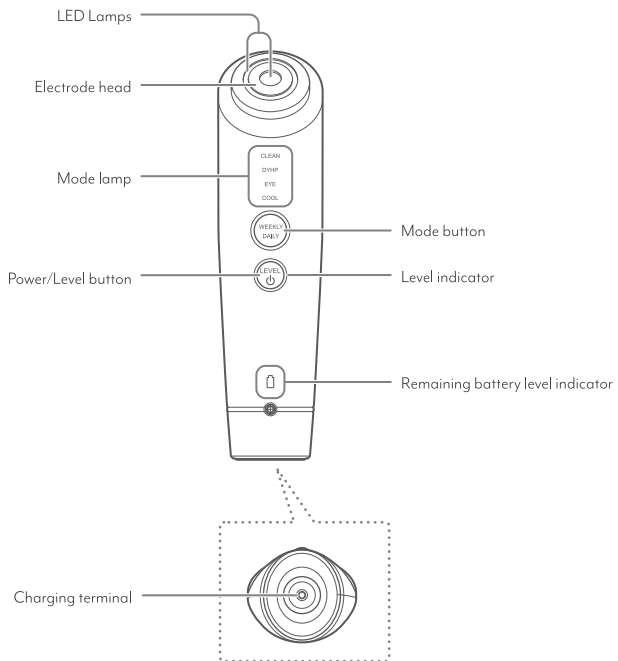

● Back view

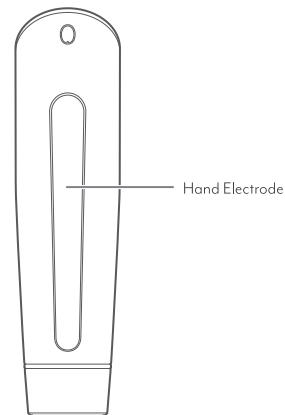

Accessories

● **Charging base**



● **Cotton stopper**
(attached to the electrode head of the main body when packaged)

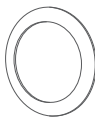

Use this stopper to apply a cotton to the electrode head (page 18).

● **USB charging cable**
(USB Type-C™)

* For use exclusively with this product. Do not use attachments other than those provided with the product.

* The design and specifications of the device and peripheral accessories are subject to change for improvement purposes without notice.

Functions

Timer

One short beep will sound to indicate the half-way point in the operating time.
Refer to pages 16 and 17 for each mode's operating time.

Standby Mode (only if Weekly Care is selected)

When treatment in a certain mode is completed, the device will emit rapid beeping sounds and the following mode indicator flashes (Standby Mode indicates operation has stopped).
Refer to pages 16 and 17 for each mode's operating time.

Briefly press the mode button again to start the mode that was flashing.

When treatment in COOL Mode has finished, the device will emit rapid beeping sounds and the power will switch off automatically without the device going to Standby Mode.

Auto Power-off

If the device is not used within approx. 5 minutes of going into Standby Mode, it will emit beeping sounds and switch off automatically.

Before Use

Charge the device

Using a household power outlet

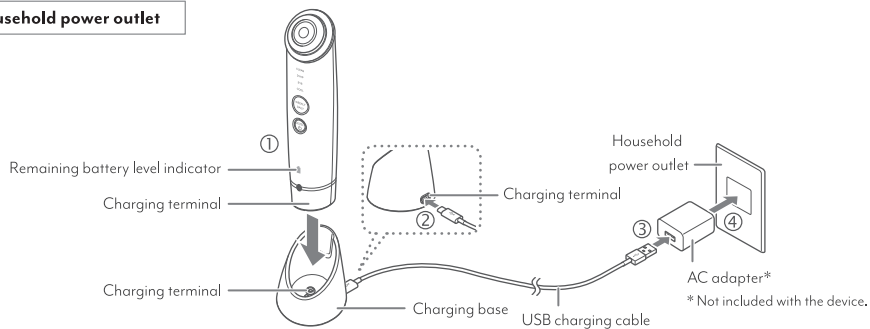

Using a computer

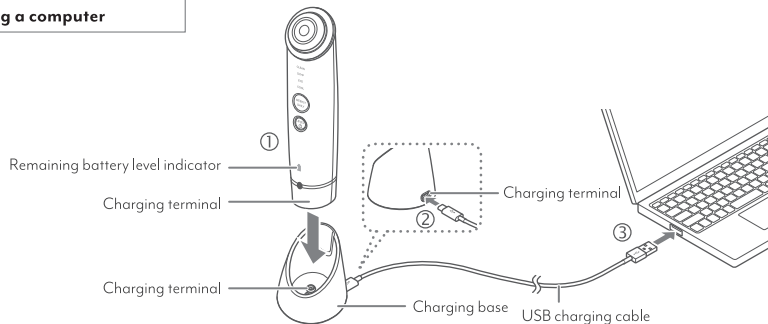

To begin charging, place the main body of the device on the charging base that is connected to the USB charging cord, as shown in the diagram.

* If charging does not begin after about 10 seconds, check that the USB charging cable and the AC adapter (commercially available) are connected properly.

Charging	The remaining battery level indicator flashes in white.
When charging is complete	The remaining battery level indicator lights up in white for 5 seconds and then turns off.
Charging time	Approx. 3 hours (room temperature approx. 25° C) The actual charging time will differ depending on the remaining battery level, the charging environment, and the AC adapter (commercially available) being used.
Operating time	Approx. 30 minutes (at the maximum power in DYHP Mode). The actual charging time will differ depending on the remaining battery level, the charging environment, and the AC adapter (commercially available) being used.

You can check the remaining battery level with the remaining battery level indicator.

Remaining battery level indicator	
White light	The battery is sufficiently charged.
Red light	The battery level is low.
Red flash	Charge the battery.



- Do not overload an electrical circuit with the AC adapter (commercially available). Be sure the AC adapter is inserted directly into the wall outlet.
- Fully charge the battery before using the device for the first time.
- When using the device for the first time or when the device has not been used for an extended period of time, it is possible that you will be unable to use the device for very long even with a full charge displayed. In such cases, recharge the device before using it.
- Use only the enclosed USB charging cable.
- Do not recharge the device in locations where there are high temperatures or a high degree of humidity, such as bathrooms or washrooms.

Pre-testing on skin

When using the device for the first time, always test for its compatibility with your skin.

-  **ATTENTION**
- Be sure to perform a pre-test in order to prevent skin problems from occurring.
 - If a rash, redness, itchiness, stinging sensation, or other abnormality occurs at the pre-testing area, immediately stop the pre-test.
 - Check carefully to make sure that there are no skin abnormalities before using the device. Stop using the device immediately if the treatment does not agree with your skin.

1

Wash the inner side of your arm with a soap and water, then wipe dry with a towel.

Be sure to wipe the moisture off completely.

2

Apply your regular skin lotion to your skin and use the device in DYHP Mode on level 1 for approx. 5 minutes (page 19).

3

Make sure you are experiencing no skin abnormalities.

Continue to use the product only if you experience no redness or burning sensation on your skin within 24 hours.



How to Use

Precautions

Read the items below carefully before use and use only as directed.

- **Be sure to perform a pre-test before using the device for the first time (page 14).**
- **Be sure to move the device on your skin while it is in use.** Using the device continuously on the same area may cause burns or other injuries.
(except in EYE CARE Mode and COOL Mode)
- **The warmth of the RF (radio frequency) changes depending on the type of skincare products used and the skin's condition at the time of treatment.**
- **Do not use the device on the upper eyelids (except in COOL Mode), lower eyelids, or outer corner of the eye (except in EYE CARE Mode and COOL Mode).**

* The LED light can be used over the upper eyelids, lower eyelids, and outer corner of the eye. Close your eyes and hold the device at least 5 cm away from your skin. Do not look directly into the LED light.
- **When holding the device, make sure that you are holding the hand electrode.**
- **Recommended environmental temperature: 15 to 30° C**

Modes

	Mode	Function	Cotton	Recommended cosmetics ^{*)}	Operating time	Level	Recommended frequency
Daily Care	DAILY	<ul style="list-style-type: none"> · EMS · Iontophoresis · LED (Red) 	Without a cotton pad	Skin lotion or serum	Approx. 3 minutes	3 levels	Every day ^{*)}
Weekly Care	CLEAN	<ul style="list-style-type: none"> · RF · Ion conduction · Vibration (only during ion emission) 	With a cotton pad	Skin lotion	Approx. 3 minutes	3 levels	2 to 3 times per week
	DYHP	<ul style="list-style-type: none"> · RF · DYHP · LED (Red) 	Either with or without a cotton pad	Serum or sheet mask	Approx. 5 minutes	3 levels	
	EYE CARE	<ul style="list-style-type: none"> · RF · Micro-currents 	Without a cotton pad	Serum for the eye area	Approx. 2 minutes	3 levels	2 to 3 times per week ^{*)}

	Mode	Function	Cotton	Recommended cosmetics*1	Operating time	Level	Recommended frequency
Weekly care	COOL	<ul style="list-style-type: none"> · Cool down · LED (Blue) 	Without a cotton pad	Place directly on the skin*4	Approx. 3 minutes	–	Treatments 2 to 3 times a week

*1 If using your regular skincare product, be sure it is water soluble. Do not use oil-based or scrubbing skincare products.

Failure to comply may cause product malfunctions or skin problems.

*2 Do not use on the same day as Weekly Care Mode (except in EYE CARE Mode).

*3 If you are concerned about dryness of the skin around the eyes, we recommend using the device 5 times a week.

*4 We recommend using the device after moisturizing your skin with a milky lotion or other skincare products.

How to attach a cotton pad to the electrode head

1

Remove the cotton stopper from the electrode head.

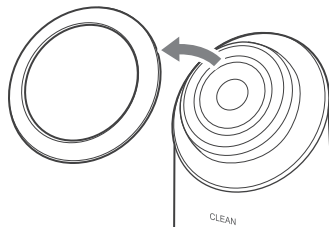

2

Place a piece of cotton on top of the electrode head and press the cotton stopper down over the cotton.

- If the cotton stopper does not fit properly on the electrode head, please use a larger and thinner piece of cotton. Because thick cotton pads are difficult to fix in place, split them in half before use.
- If the cotton pad is too thick, the thermal action of the RF treatment may be adversely affected and you will feel less heat.

3

Apply your regular skin lotion to the cotton pad.

- Make sure the skin lotion covers the entire surface of the electrode head.

ATTENTION

- If the cotton pad becomes dry, add more skin lotion.

Basic method of use

1

Remove makeup and gently cleanse your face.

• Remove oil and dirt from your skin so that it is in a clean condition prior to a treatment.

* COOL Mode can be used over makeup.

2

Attach cotton pad to the electrode head if necessary and apply skin lotion to the cotton pad.

Refer to page 18 for information on how to attach the cotton pad.

3

Turn on the device

Hold down the Power/Level button (hold down the button for approx. 3 seconds or longer).

The device will emit a beeping sound, the mode button (DAILY) lights up, and DAILY Mode starts.

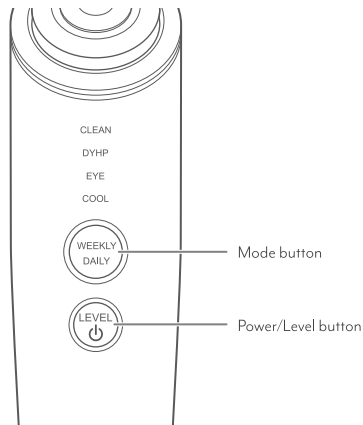

4

Select the mode

To change the mode, press and hold or briefly press the mode button.

If Daily Care is selected, the mode button (DAILY) lights up.

If Weekly Care is selected, the mode button (WEEKLY) and the mode lamp for the selected mode light up.

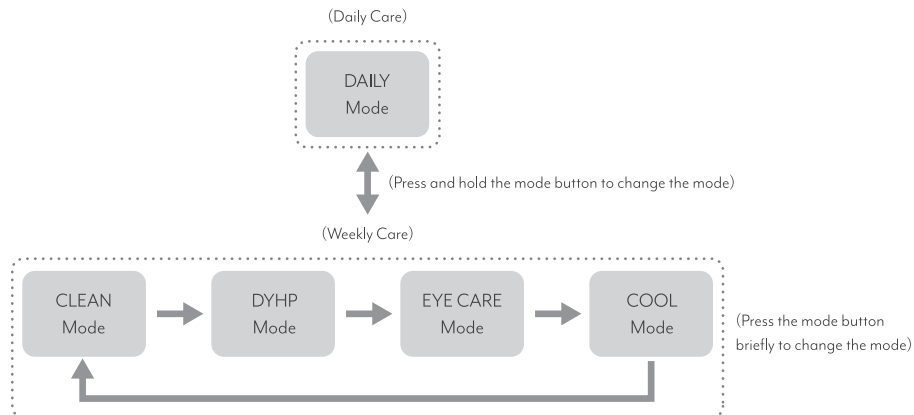
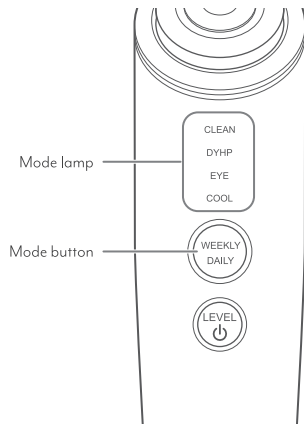

- Press and hold the mode button to toggle between Daily Care and Weekly Care.
- Press and hold the mode button when in Weekly Care Mode to switch to DAILY Mode.

For information about each mode, refer to 'Modes' (pages 16 -17).

5

Select the treatment level (intensity) (except in COOL Mode)

• Each time you briefly press the Power/Level button, the device will beep once and the level will change.

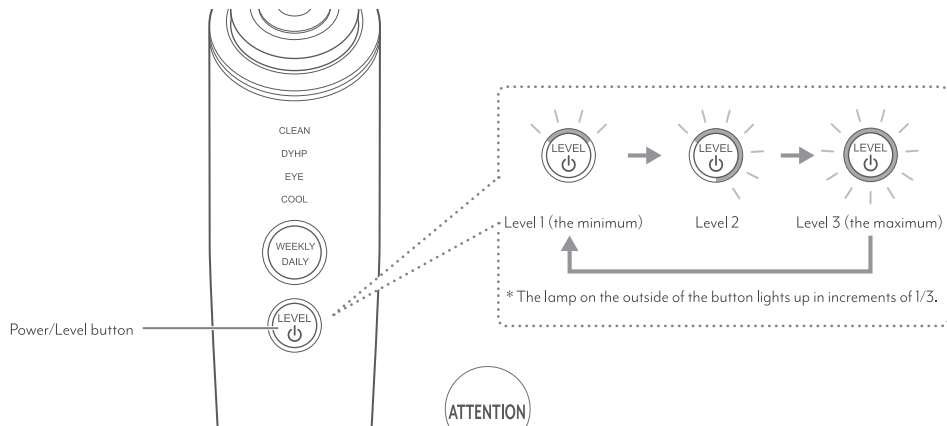

ATTENTION

- Be sure to start using the device from Level 1.
- Do not use the device at a level which pain can be felt.

6

Hold the device with your hand touching the hand electrode (the silver rim) on the rear.

- If your hand is not touching the hand electrode, it cannot operate correctly.

7

Apply the electrode head to your skin and move the head over the area being treated.

- When DAILY Mode is finished, the device will automatically turn off.
- When the treatment in each Weekly Care Mode is finished, the device will go into Standby (except when in COOL Mode). Select your preferred mode to start the next mode.
- If you want to turn the power off during use, press and hold down the Power/Level button.

- Refer to 'How to use the device on your skin' (pages 23-25) to learn how to move the device.
- Refer to pages 16 and 17 for each mode's operating time.

ATTENTION

- During use, make sure the electrode head is firmly touching the skin.

8

Care for the skin after treatment

- When you have finished treatment, rub the remaining lotion into your skin before using your usual basic skincare products to condition it.

ATTENTION

- Clean the main body of the device after each use (page 26).

How to use the device on your skin

- Recommended speed for moving the device: approx. 2 cm per second
- * If the treatment temperature feels too hot, move the head more quickly.
- One short beep will sound to indicate the half-way point in the operating time. When you hear the beep, begin care on the other side of your face.

ATTENTION

- Use in a position in which the entire surface of the electrode head comes in a contact with your skin.
- Be sure to move the device over the skin as you use it (except when using the device in EYE CARE Mode and COOL Mode). Using the device continuously on the same area may lead to burn injuries.
- Do not use the device on the upper eyelids (except in COOL Mode), lower eyelids, or outer corner of the eye (except in EYE CARE Mode and COOL Mode).
- * The LED light can be used over the upper eyelids, lower eyelids, and outer corner of the eye. Close your eyes and hold the device at least 5 cm away from your skin. Do not look directly into the LED light.

DAILY Mode

Move the electrode head over the skin in the direction of the arrows shown below. The LED light can be used to treat the upper eyelids, lower eyelids, and outer corner of the eye.

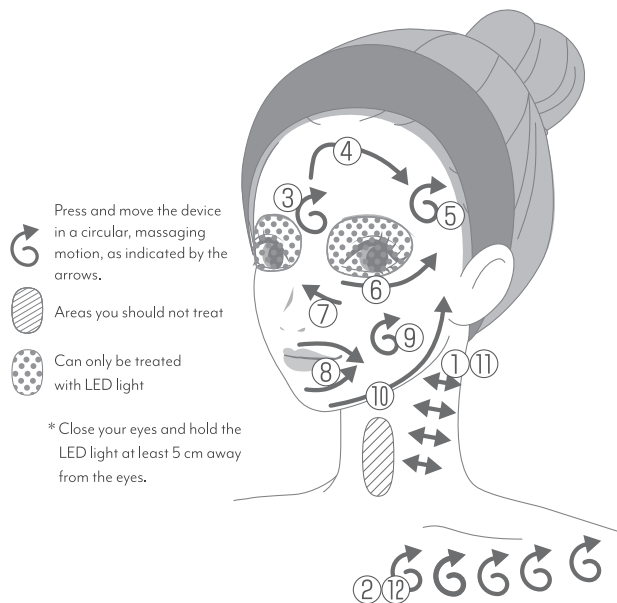

CLEAN Mode

Move the electrode head over the skin in the direction of the arrows shown below.

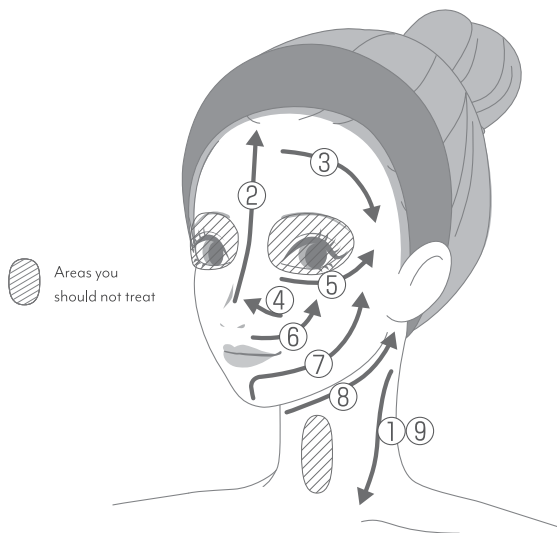

DYHP Mode

Move the electrode head over the skin in the direction of the arrows shown below. The LED light can be used to treat the upper eyelids, lower eyelids, and outer corner of the eye.

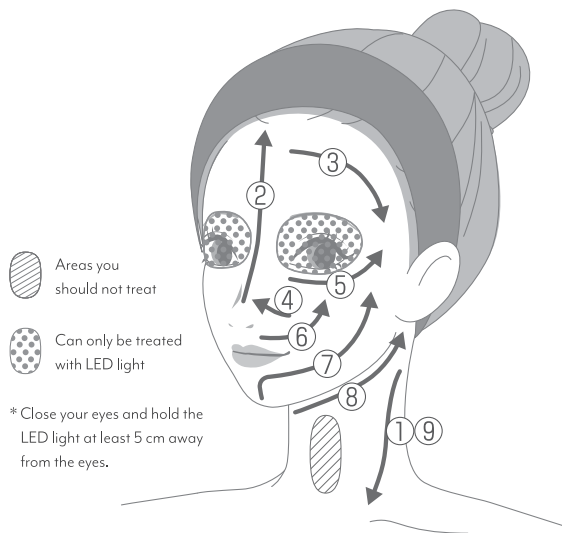

EYE CARE Mode

Press the electrode head repeatedly on your face from the inner corner to the outer corner of the eye as if stamping on the skin (Press → Release → Move electrode head). Press down on the skin for approx. 3 seconds.

If you are concerned about dryness of the skin around the eyes, we recommend using the device for 2 minutes per treatment, twice a day, 5 times a week.

* Do not press down continuously on the skin for longer than 3 seconds.

* Do not move the device while pressing.

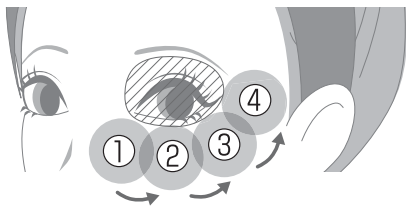

Areas you should not treat: Upper eyelids

* The device can be used around the eyes (lower eyelids, outer corner of the eye)

COOL Mode

Press the electrode head repeatedly on your face as if stamping on the skin (Press → Release → Move electrode head).

* The device can also be used over the upper eyelids, lower eyelids, and outer corner of the eye.

* When using the LED light on the eyelids, be sure to close your eyes and keep the electrode head at least 5 cm away from the skin.

After Treatment

How To Clean

Clean the device after each use for hygienic reasons.

WARNING

- When cleaning the device, check to make sure it is not charging and that the power is switched off.

1

To clean the device and electrode head, wipe them with a damp and well-wrung cloth to remove any dirt.

Wash the cotton stopper with water after removing it from the main unit.

2

Wipe the entire device with a dry cloth and store it after removing all moisture.

ATTENTION

- Do not splash water on the main body of the device or the charging base or immerse them in water.
- Do not leave the device with lotion on it.
- Ensure no moisture is left on the charging terminals.
- Do not wipe the device with solvents such as alcohol, thinner, benzene, nail polish remover, kerosene, chemicals or polishing powder.



Storing

- If you will not be using it for an extended period, clean the device before storing it.
- Unplug the USB charging cable when not in use.
- Avoid storing the device near a heater or in a bathroom or other high-temperature/high-humidity location. Also, avoid unstable locations or places where there is exposure to direct sunlight.
- Keep the device out of the reach of children.

Maintenance and Inspections

- If you have not used the device for an extended period, inspect it carefully and check that it works properly and safely before using it again.
- If the device is malfunctioning, go to 'Troubleshooting' (page 28) and attempt to identify the problem before arranging to have the device repaired. If the problem persists, contact your local distributor, making sure that you have your purchase details ready when you call.
- If the device malfunctions, appears damaged, or needs service, please contact your local distributor.

Additional Information

Troubleshooting

If you perceive any abnormality while using the device, verify the following points before arranging to have it repaired.

Problem	Possible causes and solutions
The device does not turn on	→ Press and hold the Power/Level button for approx. 3 seconds or longer (page 19).
	→ The device has run out of power. Charge the battery (page 12).
I cannot recharge the device.	→ Insert the AC adapter (commercially available) or USB charging cable properly (page 12).
	→ The main body may not be set correctly on the charging base. Set the main body correctly on the charging base (page 12).
The device is too warm.	→ The device is being used continuously. Turn off the device and wait at least one hour before using it again.
The level (strength) does not change.	→ The intensity level cannot be selected for COOL Mode.
COOL Mode is not very cool.	→ COOL Mode is being used continuously. Turn off the device and wait at least 30 minutes before using it again.
	→ The device is being used in an environment where the temperature exceeds the recommended range. Use the device within a temperature range of 15 to 30°C.
The EMS effect feels strong (unpleasant tingling, painful)	→ Lower the level by pressing the Power/Level button.
	→ The entire surface of the electrode head is not touching the skin. Use a mirror to check that the entire surface touches the skin.

Problem	Possible causes and solutions
<p>The EMS feels weak (or you cannot feel it)</p>	→ Raise the level by pressing the Power/Level button.
	→ The skin lacks moisture. Moisturize your skin with lotion before use.
	→ You are not applying the device along muscles. Apply the electrode head along muscles (page 23).
<p>The treatment temperature is too high (except when using the device in COOL Mode).</p>	→ You are using the device without moving the electrode head. Except when in COOL Mode, be sure to move the electrode head over your skin during the treatment.
	→ The speed may be too slow. Move the device a little quicker.
<p>I cannot feel any warmth.</p>	→ The device is in standby or Auto-off status (page 11). Press the mode button to start the mode of your choice (page 16).
	→ The skin lacks moisture. Moisturize your skin with lotion before use.
	→ You are moving the device too quickly. Move the device a little slower.

Frequently Asked Questions

Q How much of the skin lotion should I use each time?

A As a general guide, when using cotton pads, be sure the entire electrode head is moistened with skin lotion. We recommend adding more skin lotion if you feel there is not enough.

Q What is the recommended frequency and duration of use?

A

The recommended times are:

[Daily Care]

- DAILY Mode: 3 minutes per treatment, once a day

[Weekly Care]

- CLEAN Mode: 3 minutes per treatment, once a day, 2 to 3 times a week
- DYHP Mode: 5 minutes per treatment, once a day, 2 to 3 times a week
- EYE CARE Mode: 2 minutes per treatment, once a day, 2 to 3 times a week
- If you are concerned about dryness of the skin around the eyes, we recommend using the device for 2 minutes per treatment, twice a day, 5 times a week.
- COOL Mode: 3 minutes per treatment, once a day, 2 to 3 times a week

Do not use Daily Care and Weekly Care (except in EYE CARE Mode) on the same day. The above is also recommended if you only use one mode separately.

Q I don't feel any warmth from the RF when using the device in CLEAN/DYHP/EYE CARE modes.

A Move the electrode head more slowly or press harder against the skin surface. It is also possible that the moisture on the cotton pad is insufficient. Add more skin lotion or gel.

Q The cotton pad is not picking up any dirt.

A Dirt is removed even though it may not be visible on the cotton. The amount of visible dirt on the cotton can vary among individuals.

Q The electrode head does not warm up when I use RF Mode.

A The RF does not warm the electrode head. Rather, it uses the power of radio frequencies to warm your skin.

Product Specifications

Rated input	5 V DC 1.0 A (Charging base)
Rated output	9 V DC 0.55 A (Charging base)
Power consumption	Approx. 4.5 W (when charging)
Battery	Lithium-ion battery
Charging time	Approx. 3 hours * The actual charging time will differ depending on the remaining battery level, the charging environment, and the AC adapter (commercially available) being used.
Operating time	Approx. 30 minutes (at maximum power in DYHP mode) * The actual charging time and operating time will differ depending on the remaining power and the charging environment.
Outside dimensions	Main body (with cotton stopper): Approx. W 47 x D 44 x H 176 (mm)
Weight	Main body (with cotton stopper): Approx. 210 g
Materials	Main body: ABS resin and silicon rubber Electrode head: PET resin and stainless steel Hand electrode: Stainless steel
Country of origin	Japan
Accessories	One charging base One USB charging cable (USB Type-CTM) One cotton stopper (attached to the electrode head of the main body before packaging) User's Manual
Recommended environmental temperature	15°C to 30°C

After-sales service

Rechargeable battery

- The rechargeable battery is a consumable item. This appliance contains batteries that are non-replaceable.
- The battery is expected to last 300 charge cycles. If the device no longer operates for more than a short period of time even after the battery has been recharged, the battery may have reached the end of its service life.
- For battery replacement, please contact customer service.

Disposing of the device

- Follow your local government rules for proper disposal of this product.
- This product uses a lithium-ion battery. For information on disposing of batteries, see 'Disposing of the battery' and 'Removing the battery' below (page 33).



Correct Disposal of this product

This marking indicates that this product should not be disposed with other household wastes throughout the UK and EU. To prevent possible harm to the environment or human health from uncontrolled waste disposal, recycle it responsibly to promote the sustainable reuse of material resources. To return your used device, please use the return and collection systems or contact the retailer where the product was purchased. They can take this product for environmental safe recycling.



Disposing of the battery

The lithium-ion battery used in this product is a valuable recyclable resource.

- The battery must be removed from the appliance before it is disposed of.
- Be sure to turn off the power and disconnect the AC adapter (sold separately) before removing the batteries.
- Use a screwdriver to remove the battery, being careful not to injure yourself.
- When removing the battery, be careful not to damage it with a hard object. * Failure to comply may cause the generation of heat or a fire.
- Bring the removed battery to the appropriate collection point for disposal.

Removing the battery

1

Remove the screw cover and the rubber sheet with a thin, sharp object, then remove the screw.

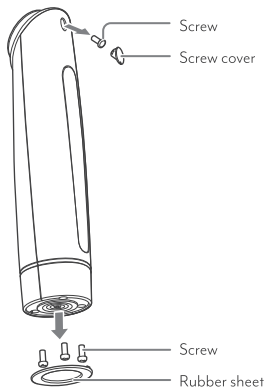

2

Remove the bottom housing

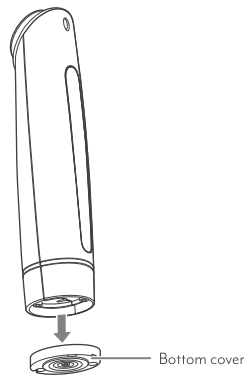

3

Remove the back cover

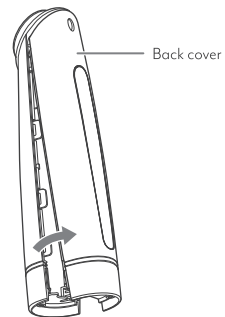

4

Disconnect the battery cable

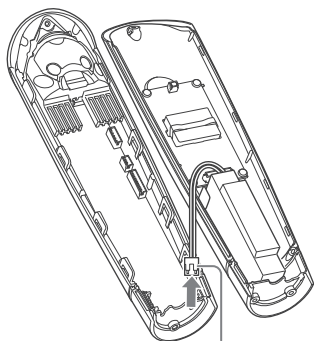

Battery cable

5

Remove the battery

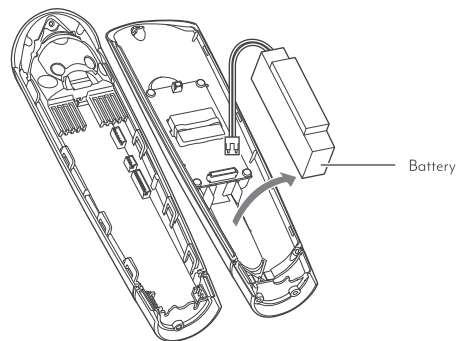

Battery



ATTENTION

- This image is intended to be used for disposing of the product, not repairing it. Do not disassemble the product except for disposal. Failure to comply may cause a fire, electric shock or other injuries.

Warranty

If you have purchased from www.global.ya-man.com,

Warranty: Please register your device at <https://global.ya-man.com/apps/warranty/registrants/new>

Contact: inquiries to contactus@ya-man.com

If you have purchased from local distributor,

Warranty: Please contact your local distributor

User's manual (WEB)

User's manual is also available at following address:

<https://www.ya-man.co.jp/en/support/documents/>

Marking



detachable supply unit